

ALPS RSAON12M9 „touch sensitive“ 100mm 10K mono Motorfader



<http://www.potentiometer4audio.eu/>

info@potentiometer4audio.eu

Gabriele Perdomo
Im Brühl 72
75443 Ötisheim
Deutschland / Germany

Tel. +49 7041 8141686
Fax: +49 3222 3720128

Customer:

No. SS-2010-7614

Date: Mar. 15, 2010

Attention:

Your ref. No.:

Your Part No.: RSA0N12M9A04

SPECIFICATIONS

ALPS'

MODEL: RSA0N12M9A04
(10k A, 10k B)

Spec. No.:

Sample No.: F 9 6 4 7 4 3 7 M

RECEIPT STATUS

RECEIVED

By Date

Signature

Name

Title

ALPS
ALPS ELECTRIC CO., LTD.

DSG'D

Y. Shimizu

APP'D

y. kato

ENG. DEPT.

Sales

Head Office
1-7, Yukigaya-otsuka-machi, Ota-ku, Tokyo, 145-8501 Japan
Phone,+81(3)3726-1211

B6523

Q1003#03A (EA)

SPECIFICATIONS

1. THIS SPECIFICATIONS APPLY TO RSAON12M9A04 POTENTIOMETER.

2. CONTENTS OF THIS SPECIFICATIONS.

5SA02RM004

5SAORM-01

5S00ORM-01

4S0001-200

SA02RM914

3. MARKING

• MARKING ON ALL UNITS

DATE CODE, RESIST. VALUE, TAPER

• NOTES

• Marking ⇒ in specifications shows standard and condition for application.

• CAUTION

1. For the export of products which are controlled items subject to foreign and domestic export laws and regulations, you must obtain approval and/or follow the formalities of such laws and regulations.

2. Products must not be used for military and/or antisocial purposes such as terrorism, and shall not be supplied to any party intending to use the products for such purposes.

3. Unless provided otherwise, the products have been designed and manufactured for application to equipment and devices which are sold to end-users in the market, such as AV (audio visual) equipment, home electric equipment, office and commercial electronic equipment, information and communication equipment or amusement equipment. The products are not intended for use in, and must not be used for, any application of nuclear equipment, driving control equipment for aerospace or any other unauthorized use.

With the exception of the above mentioned banned applications, for applications involving high levels of safety and liability such as medical equipment, burglar alarm equipment, disaster prevention equipment and undersea equipment, please contact an Alps sales representative and/or evaluate the total system on the applicability. Also, implement a fail-safe design, protection circuit, redundant circuit, malfunction protection and/or fire protection into the complete system for safety and reliability of the total system.

4. Before using products which were not specifically designed for use in automotive applications, please contact an Alps sales representative.

5. The products shall be stored in the original packaging and kept at room temperature and humidity, out of direct sunlight, and away from any and all corrosive gas. The products shall be completely used as soon as possible, but no later than 6 months from the date of delivery.

Once product packaging is opened, the complete quantity of such products shall be promptly used.

CLASS. NO.	TITLE
	MASTER TYPE POTENTIOMETER (SLIDE)

1. Environment 一般事項

1. 1 Operating temperature range 使用温度範囲 -10~60°C

1. 2 Storage temperature range 保存温度範囲 -30~70°C

1. 3 Test conditions 試験条件

Unless otherwise specified, the standard range of atmospheric conditions for making measurements and test is as follows.

Ambient temperature : 5°C to 35°C

Relative humidity : 45% to 85%

Air pressure : 86kPa to 106kPa

If there is any doubt about the results, measurements shall be made within the following limits.

Ambient temperature : 20±2°C

Relative humidity : 60 to 70%

Air pressure : 86kPa to 106kPa

試験及び測定は特に規定がない限り温度5~35°C, 相対湿度45~85%, 気圧86~106kPaの標準状態のもとで行う。

ただし、判定に疑義を生じた場合は温度20±2°C, 相対湿度60~70%, 気圧86~106kPaにて行う。

2. Appearance 外觀

The potentiometer shall be well done and not have any excessive rust, crack, split, poor plating and discolor in any portion.

各部の仕上げは良好で機能上有害なサビ, キズ, フレ, メッキ不良及び剥離などがあってはならない。

3. Electrical characteristics 電気的性能

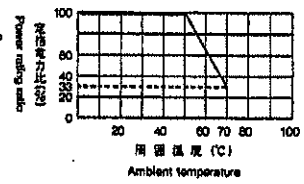
Item 項目	Conditions 条件	Specifications 規格
3. 1 Nominal total resistance and tolerance 公称全抵抗値および許容差	Measurement shall be made by the resistance between terminal 1 and 3 with lever setted at terminal 1 or 3. レバーを端子1又は、3の終端におき、抵抗器の端子1-3間の抵抗値を測定する。	10 K, $\pm 20\%$
3. 2 Power rating 定格電力	Power rating is based on continuous full load operation at the maximum voltage between terminals 1 and 3. Power rating vs. ambient temperature shall be denoted on the following graph. 端子1と3の間に連続負荷することができる最大電力。周囲温度に対する電力軽減曲線は右図とする。 	Terminals 1, 2, 3 side 1. 2. 3端子側 Audio track 0.25w Terminals 1', 2', 3' side 1'. 2'. 3'端子側 Servo track 0.5 W
3. 3 Rated voltage 定格電圧	Rated voltage $E = \sqrt{PR}$ (V) P: Power rating 定格電力 (W) R: Nominal total resistance 公称全抵抗値 (Ω) When the rated voltage exceeds the maximum operating voltage, the maximum operating voltage shall be the rated voltage. ただし、定格電圧が最高使用電圧を越える場合は、この最高使用電圧を定格電圧とする。	Maximum operating voltage 最高使用電圧 A, C, 350 v D, C, 10 v
3. 4 Resistance law (Taper) 抵抗変化特性	Measurement shall be made by the resistance law method, 電圧法にて測定 Measurement shall be made at the position of right diagram from the edge at the side of terminal 1. When based on terminal 3, from the edge at the side of terminal 3. Output voltage between terminals 1 and 2 / Applied voltage between terminals 1 and 3 $\times 100(\%)$ $\frac{1-2 \text{端子間出力電圧}}{1-3 \text{端子間印加電圧}} \times 100(\%)$ $20 \log \frac{\text{Output voltage between terminals 1 and 2}}{\text{Applied voltage between terminals 1 and 3}}$ (dB) $20 \log \frac{1-2 \text{端子間出力電圧}}{1-3 \text{端子間印加電圧}}$ (dB)	Unit (単位) <input checked="" type="checkbox"/> % <input type="checkbox"/> dB TAPERED CURVE Terminals 1, 2, 3 side 1. 2. 3端子側 Audio track JIS "A" (SAS24) Terminals 1', 2', 3' side 1'. 2'. 3'端子側 Servo track ALPS "B" (SBS76)

 ALPS ELECTRIC CO., LTD.					
SYMB.	DATE	APPD.	CHKD.	DSGD.	TITLE
		設1 02.2.25 阿部	設1 02.2.25 八代	設1 02.2.25 玉田	SPECIFICATIONS
					DOCUMENT NO.
					5SA02RM004 (1/2)

CLASS.NO.	TITLE
	MASTER TYPE POTENTIOMETER (SLIDE)

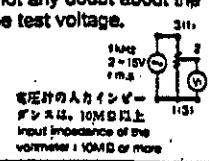
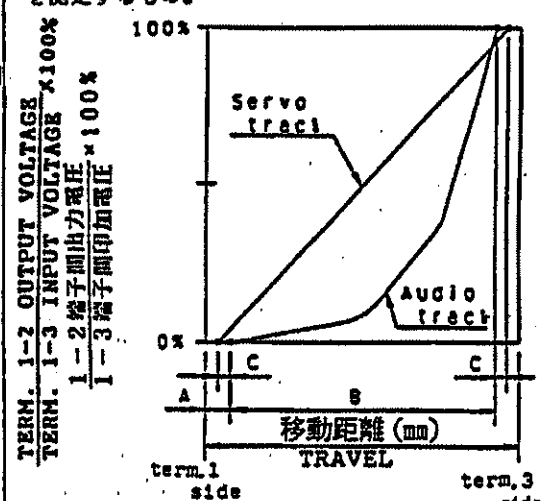
Item 項目	Conditions 条件	Specifications 規格
3.5 Attenuation and insertion loss 最大減衰量と挿入損失	The attenuation and insertion loss at each end of lever travel shall be measured. しゅう動子を移動距離の各終端に置いたとき 最大減衰量、挿入損失を測定する。 The voltage of 2 Vr.m.s. to 15 Vr.m.s. shall be applied between terminal 1 and 3 by measuring frequency at 1 kHz The output voltage shall be measured between terminals 1 and 2 and between terminals 2 and 3. if there is not any doubt about the results, DC voltage shall be used as the test voltage. 端子1-3間に1kHzで2~15V (正弦波実効値)の電圧を加え、端子1-2間、端子2-3間の出力電圧を測定する。なお、判定に疑義が生じなければ、試験電圧として直流を用いてもよい。 	Terminals 1,2,3 side 1. 2. 3端子側 Audio track Attenuation 80 dB or more 最大減衰量 80 dB 以上 Insertion loss 挿入損失 within 0.1 dB以内 Terminals 1',2',3' side 1'. 2'. 3'端子側 Servo track Attenuation 70 dB or more 最大減衰量 70 dB 以上 Insertion loss 挿入損失 within 0.1 dB以内
3.6 Noise しゅう動雑音	DC 20V, when the rated voltage is 20V or less, its rated voltage shall be applied to the terminals between 1 and 3. And then the noise shall be measured by the specified speed. For other procedures, refer to IEC Pub. 393-1-4.15 Traveling speed:20mm/sec 端子1-3間に直流電圧20V(定格が20V以下の時は、その電圧)を加え、レバーを20mm/秒の速さで移動させ、このときに発生する雑音電圧を測定する。その他 JIS C 5261A法による。	Less than 47 mVp-P 未満 Measuring condition: exclude pop-noise ただし、ノイズは除外とする。
3.7 Insulation resistance 絶縁抵抗	A voltage of 250V DC shall be applied for 1 min., after which measurement shall be made. D.C.250Vの電圧を1分間印加して測定。	Between individual terminals and frame/lever Between adjacent terminals 端子-レバー間 端子-枠間 独立した抵抗素子の端子間 100MΩ or more 以上
3.8 Dielectric strength 耐電圧	Trip current :2mA Measuring frequency :50/60Hz 250V AC for 1 min. A.C.250Vr.m.s. 1分間。 感度電流 2mA(周波数50/60Hz)	Between individual terminals and frame/lever Between adjacent terminals Without damage to parts, arcing or breakdown etc. 損傷、アークおよび絶縁破壊を生じないこと。
3.9 Voltage control range 電圧可変範囲	1. 2. 3端子と1'. 2'. 3'端子の電圧可変範囲を測定するもの。 	A=REF. 2 mm B=REF. 96 mm C= 1±0.5 mm
3.10 Conductive resistance 導通抵抗	Touch sense track resistance (lever between terminal ①) タッチセンサ用トラック(レバー - 端子①間)	1kΩ MAX.

ALPS ELECTRIC CO., LTD.

SYMB.	DATE	APPD.	CHKD.	DSGD.	TITLE
		設1 02.2.25 阿部	設1 02.2.25 八代	02.2.25 五田	SPECIFICATIONS
					DOCUMENT NO. 5SA02RM004 (2/2)

USED ON <i>100 mm TRAVEL TYPE</i>	NAME RESISTANCE TAPER
 ALPS ELECTRIC CO., LTD. 1-7 YUKIGAYA OTSUKA-CHO OTA-KU TOKYO JAPAN	TITLE SPECIFICATIONS

TAPERED CURVE: JIS 'A'

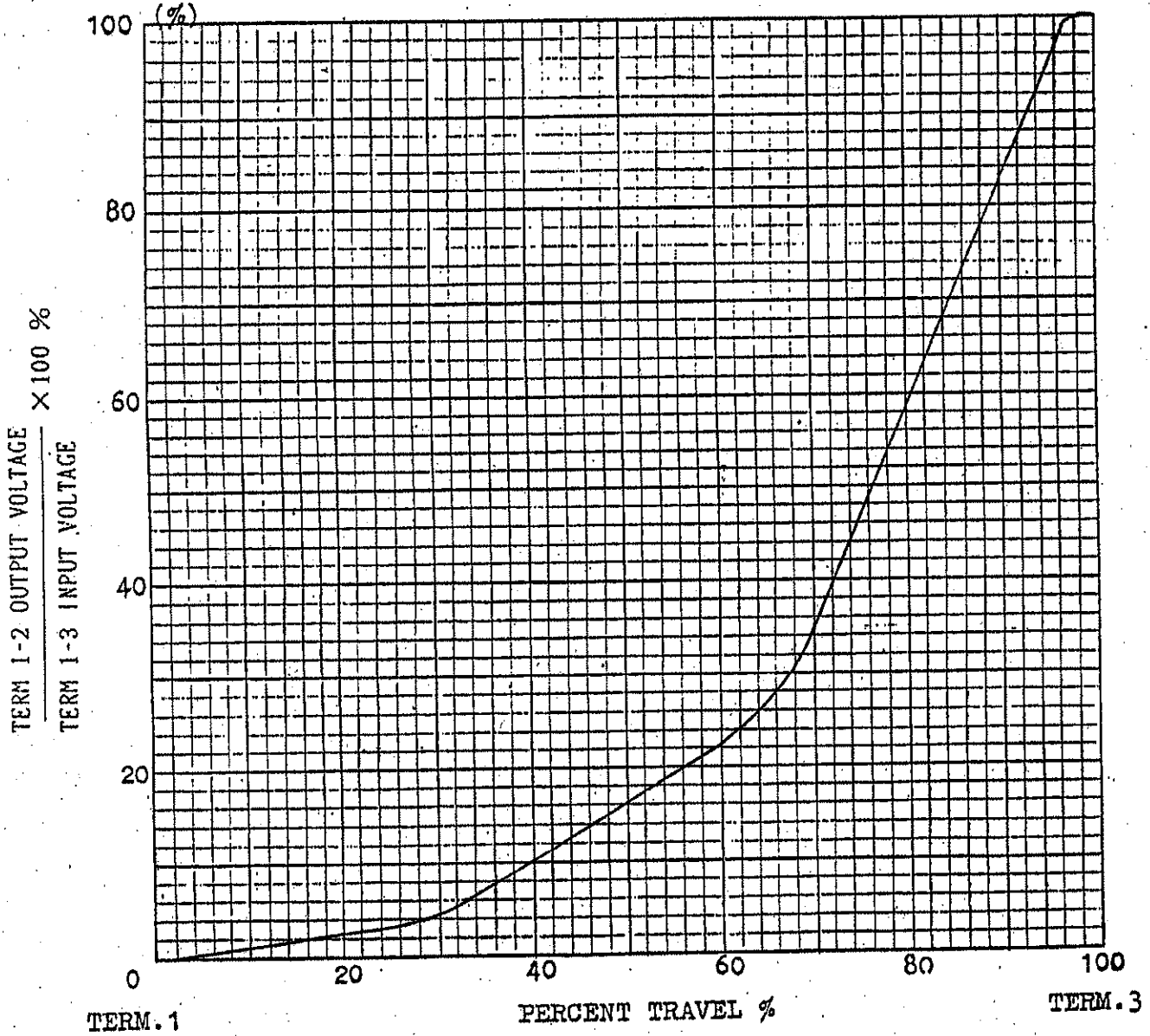

NOTES: PERCENT VOLTAGE
CHECK POINT

60% TRAVEL FROM TERM. 1

TOLERANCE

15 - 30%

				APPD.	CHKD.	DSGD.	NAME
				<i>Feb. 24 '87</i>	<i>Feb. 23 '87</i>	<i>Feb. 23 '87</i>	RESISTANCE TAPER
SYMB.	DATE	APPD.	CHKD.	DSGD.	<i>M. Inoue</i>	<i>S. Saitoh</i>	<i>R. Sato</i>
							DWG. NO. SAS 24

4. Mechanical characteristics 機械的性能

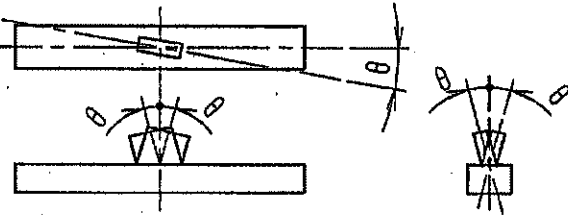
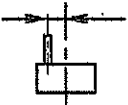
Item 項目	Conditions 条件	Specifications 規格
4.1 Lever travel レバ - 移動距離		100 ± 1 mm
4.2 Operating force 作動力	Traveling speed : 20mm/s Operating position : Tip of the lever 移動速度は20mm/秒とする。 操作位置はレバ - 先端部とする。	0.8 ± 0.5 N
Starting force 始動力	Traveling speed : 20mm/s. Operating position : Tip of the lever 移動速度は20mm/秒とする。 操作位置はレバ - 先端部とする。	Operating force + 1N MAX. 作動力 + 1N 以下
4.3 Lever travel stop strength レバ - の移動止強度	A static load of 100N shall be applied at the point 5mm from top surface of the case for both ends in the direction of lever travel for 10s. しゅう動距離の両末端において、枠上面より5mmの位置に100Nの力を10秒間加える。	Without excessive play or poor contact. 著しいカタ及び接触不良を生じない事。
4.4 Side thrust of the lever レバ - の横押し強度	A static load of 20N shall be applied at the point 5mm from top surface of the case in a direction perpendicular to the axial direction for 10s, with the potentiometer mounted in assembly conditions. 本体をシャーシに固定し、枠上面より5mmの位置にレバ - 移動方向に対して直角方向に20Nの力を10秒間加える。	Without deformation or breaks in the sliding part and contact part. 操作部及び関連部品に変形、破損がない事。
4.5 Thrust and tensile lever レバ - の押し引き強度	Thrust and tensile static load of 50N shall be applied to the potentiometer in the lever direction for 10s. レバ - の押し方向及び引張り方向に、50Nの力を10秒間加える。	Without damage such as bad sliding and braking or play in the lever. Electrical characteristics shall be satisfied. レバ - のカタ及び破損、しゅう動ムラ等がなく、電気的性能を満足する事。
4.6 Displacement of lever レバ - の横振れ	A torsion moment of 25mN·m shall be applied at the lever in a direction perpendicular to the axial direction and then the displacement shall be measured. レバ - に25mN·mの曲げモーメントを移動方向に対して、直角に加えレバ - 先端で測定する。	2 (2xL/25) mmP-P or less 以下 L=Length of lever レバ - 長さ
4.7 Lever inclination and torsion レバ - の傾き及びねじれ		θ shall be 2° or less. θ は2度以下。
4.8 Distance from the center of the lever レバ - のセンターズレ	After sliding lever as far as it will go in each direction, the distance from the center of the lever to the middle of the mounting screw hole shall be measured at the both ends. 取付けネジ 穴中心に対するレバ - のセンターからのずれを、片側ごとに測定する。 	0.5mm or less on each end. 片側 0.5mm以下
4.9 Resistance to soldering heat はんだ耐熱	Bit temperature : 350°C or less Application time of soldering iron : 3 s or less 温度350°C以下、時間3秒以内。 但し、端子に異常加圧のない事。	Change in total resistance is relative to the value before test : 5% without excessive looseness of terminals and failure contact 全抵抗値の変化は初期値の±5%以内。 著しいカタ、接触不良を生じない事。

ALPS ALPS ELECTRIC CO., LTD.

APPD
1枚-2G
00.1.13
相沢

CHKD
1枚-2G
00.1.13
阿部

DSGD
1枚-2G
00.1.12

TITLE
SPECIFICATIONS

DOCUMENT NO.
5SA0RM-01 (1/3)

SYMB DATE APPD CHKD DSGD

⑤
単.公電成通

5. Endurance 耐久性能

Item 項目	Conditions 条件	Specifications 規格
5.1 Endurance without load 無負荷 しゅう動寿命	The moving contact, without electrical load, shall be slid from one end stop to the other and returned to its original position extended over 90% or more effective distance. This procedure constitutes 1 cycle. And the moving contact shall be subjected to 600 cycles per hour, a total of 30000±200 cycles (5000 to 8000 continuous cycles for 24 hours.) 無負荷にてレハ-を600サイクル/時の速さで有効移動距離の90%以上に往たり、1日連続5000~8000サイクル、合計30000±200サイクル移動させる。	Change in total resistance is relative to the value before test: ±15% Noise: Refer to Note 1) Operating force: 0.1N~2N 全抵抗値の変化は、初期値の±15%以内 しゅう動寿命は、注記 1)による。 作動力は、0.1N~2N
5.2 Cold 耐寒性	The potentiometer shall be stored at a temperature of $-30 \pm 2^{\circ}\text{C}$ for 96 hours in a thermostatic chamber. Then the potentiometer shall be taken out of the chamber and its surface moisture shall be removed. And then the potentiometer shall be subjected to standard atmospheric conditions for 1 hour, after which measurement shall be made. $-30 \pm 2^{\circ}\text{C}$ の恒温槽中にて96時間放置し、常温常湿中に1時間放置後1時間以内に測定する。 但し水滴は、取り除くものとする。	Change in total resistance is relative to the value before test: ±20% 全抵抗値の変化は、初期値の±20%以内
5.3 Dry heat 耐熱性	The potentiometer shall be stored at a temperature of $70 \pm 2^{\circ}\text{C}$ for 240±8 hours in a thermostatic chamber. Then the potentiometer shall be maintained at standard atmospheric conditions for 1 hour, after which measurements shall be made. $70 \pm 2^{\circ}\text{C}$ の恒温槽中にて240±8時間放置し、常温常湿中に1時間放置後1時間以内に測定する。	Change in total resistance is relative to the value before test: +5/-30% Noise: Refer to Note 1) Operating force: 0.1N~2N 全抵抗値の変化は、初期値の+5~-30%以内 しゅう動寿命は、注記 1)による。 作動力は、0.1~2N
5.4 Damp heat 耐湿性	The potentiometer shall be stored at a temperature of $40 \pm 2^{\circ}\text{C}$ with relative humidity of 90% to 95% for 96±4 hours in a thermostatic chamber. And its surface moisture shall be removed. And then the potentiometer shall be subjected to standard atmospheric conditions for 1 hour, after which measurement shall be made. $40 \pm 2^{\circ}\text{C}$ 相対湿度90~95%の恒温恒湿槽中にて96±4時間放置し、常温常湿中に1時間放置後1時間以内に測定する。 但し水滴は、取り除くものとする。	Change in total resistance is relative to the value before test: +35/-5% Noise: Refer to Note 1) Operating force: 0.1~2N 全抵抗値の変化は、初期値の+35~-5%以内 しゅう動寿命は、注記 1)による。 作動力は、0.1~2N

					ALPS ALPS ELECTRIC CO., LTD.				
			APPD.	CHKD.	DSGD.	TITLE			
			1枚-2G	1枚-2G	1枚-2G	SPECIFICATIONS			
			00.1.13	00.1.13	00.1.12	DOCUMENT NO.			
			相沢	阿部	渡邊	5SAORM-01 (2/3)			
SYMB	DATE	APPD	CHKD	DSGD					

Item 項目	Conditions 条件	Specifications 規格															
5.5 Change of temperature 温度サイクル	<p>The potentiometer shall be subjected to 5 successive change of temperature cycles, each as shown in table below. Then its surface moisture shall be removed. And then the potentiometer shall be subjected to standard atmospheric conditions for 1 hour, after which measurements shall be made.</p> <p>下記条件で5サイクル試験後、常温常湿中に1時間放置後1時間以内に測定する。但し水滴は、取り除くものとする。</p> <table border="1" data-bbox="459 539 1070 827"> <thead> <tr> <th>Step 段階</th> <th>Temperature 温度</th> <th>Duration 時間</th> </tr> </thead> <tbody> <tr> <td>1</td> <td>-10±3°C</td> <td>30 min. 30分</td> </tr> <tr> <td>2</td> <td>Standard atmospheric conditions 常湿</td> <td>10~15 min. 10~15分</td> </tr> <tr> <td>3</td> <td>70±2°C</td> <td>30 min. 30分</td> </tr> <tr> <td>4</td> <td>Standard atmospheric conditions 常湿</td> <td>10~15 min. 10~15分</td> </tr> </tbody> </table>	Step 段階	Temperature 温度	Duration 時間	1	-10±3°C	30 min. 30分	2	Standard atmospheric conditions 常湿	10~15 min. 10~15分	3	70±2°C	30 min. 30分	4	Standard atmospheric conditions 常湿	10~15 min. 10~15分	<p>Change in total resistance is relative to the value before test: ±20% Noise: Refer to Note 1) Operating force: 0.1N~2N</p> <p>全抵抗値の変化は、初期値の±20%以内しゅう動雑音は、注記 1) による。 作動力は、0.1N~2N</p>
Step 段階	Temperature 温度	Duration 時間															
1	-10±3°C	30 min. 30分															
2	Standard atmospheric conditions 常湿	10~15 min. 10~15分															
3	70±2°C	30 min. 30分															
4	Standard atmospheric conditions 常湿	10~15 min. 10~15分															

Note 1) For noise specification after the test, refer to the list below.

注記 1) 試験後のしゅう動雑音規格は、下表による。

Nominal total resistance 公称全抵抗値 (kΩ) 5 ≤ Ra ≤ 50	Nominal total resistance 公称全抵抗値 (kΩ) 50 < Ra ≤ 500
Less than 150mV _{p-p} 未滿	Less than 300mV _{p-p} 未滿

					ALPS ALPS ELECTRIC CO., LTD.						
		APPD.		CHKD.		DSGD.		TITLE			
		E-2G 00.1.13		12-20 01.13		14-26 08.12		SPECIFICATIONS			
		相沢		相沢		相沢		DOCUMENT NO.			
SYMB		DATE		APPD		CHKD		DSGD		5SAORM-01 (3/3)	

CLASS.NO.	TITLE
	MASTER TYPE POTENTIOMETER (SLIDE)

Motor drive characteristics.

モータ駆動時性能

	Item 項目	Conditions 条件	Specifications 規格
1	Rated voltage 定格電圧	Between terminals of the motor モータ部端子間	10 V D.C.
2	Operating supply voltage range 使用電圧範囲	Voltage supply ripple : 0.3% or less 電源リップル0.3%以下	6 - 11 V D.C.
3	Starting current 起動電流	Supply voltage 10 V D.C. D.C.10V印加	800 mA or less 800mA以下
4	Starting force 起動作動力	Supply voltage 10 V D.C. It shall be measured at the top of lever. D.C.10V印加、測定位置は レバー先端とする。	0.2 N or more 0.2N以上
5	Moving speed of lever レバー移動速度	Supply voltage 10 V D.C. D.C.10V印加	20 mm / 0.1 sec. or more 20mm / 0.1秒 以上
6	Maximum current レバー固定時電流 (モータロック状態)	Lock the shaft of the motor and the rated vol- tage shall be applied to the motor. レバーを固定し、定格電圧を 印加する。	400 - 800 mA

					ALPS ALPS ELECTRIC CO., LTD.			
					APPD.	CHKD.	DSGD.	TITLE
					1枚-2G 99.9.07 相沢	1枚-2G 99.9.-7 阿部	1枚-2G 99.9.-6 渡邊	SPECIFICATIONS
								DOCUMENT NO.
								5S000RM-01 (1/2)
SYMB.	DATE	APPD.	CHKD.	DSGD.				FOR

Caution
ご使用上の注意

- Do not lock the lever for five seconds or more when the motor is supplied with electricity and do not use the motor under the overloaded condition. Please use the master type potentiometer with safety device for protecting the over-current in a motor drive circuit. Because part of the motor is heated excessively and the motor is burned out in case it is used under the overloaded condition continuously.
モータに通電した状態で、レバーを5秒以上固定（ロック）又は、過負荷状態でご使用しないで下さい。
ロック 又は、過負荷状態が持続しますとモータの一部が発熱焼損しますので、過電流防止用の保護回路等の安全装置をご使用下さい。
- Do not supply the electricity which is not capable of driving the lever to the motor for ten seconds or more.
(The value of current is approximately 1 to 300 mA in this case)
Please use the master type potentiometer with safety device for protecting the constant current which is minute current lasted for ten seconds or more in a motor drive circuit. Because part of the motor is heated excessively and the motor is burned out in case it is supplied with the minute current mentioned above constantly.
レバーが動作しない電流（1～300mA程度）をモータに10秒以上通電しないで下さい。通電状態が持続しますとモータの一部が、発熱 焼損します。10秒以上定電流が流れた場合、電源を切る等の回路的なご配慮をお願いします。
- Please use the master type potentiometer with a motor-drive circuit which is capable of supplying the sufficient current. This current value is 800 mA. or more.
モータの駆動回路については、800mA以上の電流供給能力を持たせて下さい。

- Do not use the master type potentiometer in the following atmospheric conditions.
Corrosive atmosphere : For example, H₂S, SO₂, NO₂, Cl₂
Do not use the master type potentiometer with the following materials.
Poison materials : Especially, siliconized materials, cyano materials formalin, phenolic materials.

腐蝕性ガス（H₂S, SO₂, NO₂, Cl₂等）はもとより、有害なガス雰囲気中及び有害なガスを発生する物質（特に有機シリコン系、シアン系、ホルマリン系、フェノール系物質等）が存在する場所でのご使用は避けるようにして下さい。
尚、セット内に於いても上記物質が存在する場合は、事前に十分ご確認下さい。

- Avoid storing the master type potentiometer in unusual atmosphere, for example, high temperature, high humidity, and low temperature.
If you store the master type potentiometer for a long time, be careful about the place for the storage and do not store the master type potentiometer more than six month even if it is stored in usual atmosphere.
保管は上記腐蝕性ガスの雰囲気中及び高温、低温、多湿の場所は避けて下さい。
尚、保管は常温常湿中の6ヶ月以内に止めていただく様にご配慮下さい。

- Avoid soldering process such as to rise up to the surface of printed-wiring-board on the side of installing potentiometer, and use the way of hand-soldering only.
(Please refer to the drawing as follows)
Please use the solder iron for preventing the damage to the master type potentiometer by electrical shock, and solder terminals of the motor as quick as possible for preventing the flux flow into the motor.
図の様にP.C.B.の上面に半田付けをする配線はお避け下さい。(半田付けは、手半田での対応として下さい。)
尚、モータ端子を半田付けする際、半田ゴテはアースの取れているものを使用しただき、フラックスのモータ部への流入を避ける様速やかに行ってください。

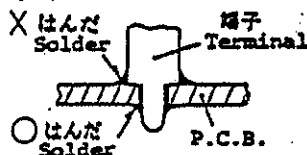

Manual Soldering

手はんだ

△350°C MAX.

Solder temperature はんだ温度: 350°C MAX.

Soldering period 時間: within 3 seconds 3秒以内

Time of soldering はんだ回数:

only one time is permitted 1回まで

					ALPS ELECTRIC CO., LTD.		
		APPD.	CHKD.	DSCD.	TITLE		
		1枝-2G 99.9.07	1枝-2G 99.9.-7	1枝-2G 99.9.-6	SPECIFICATIONS		
△	04-02-13	相沢	玉田		DOCUMENT NO.		
SYMB.	DATE	APPD.	CHKD.	DSCD.	5S000RM-01 (2/2)		

ご使用上の注意
PRECAUTION IN USE

1. 偏心ツマミをご使用になる場合
 レバーの中心より離れたところを作用点としてご使用になる場合、可能な限り
 下図A寸法を短くしてご使用下さい。
 If it will be used the operating point away
 from the center line of the lever, it should
 be shorter as possible.

2. レバー長さについて
 レバー長さについては、ツマミを含めて、下図B面より極力短いものを
 ご使用願います。レバー長さについては、作用点までの距離が短いほど
 しゅう動感触が良好となり、長いほど好ましくない感触になります。
 About the length of lever
 If conditions permit, it is advisable to use
 the shortest possible lever.
 The longer the length up to operating point,
 the more unfavorable slide feeling
 will be given.

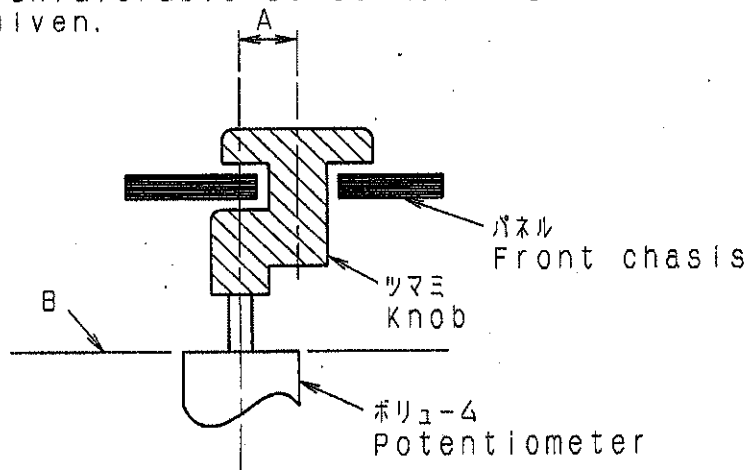

3. レバーの駆動に関しては上記内容を考慮の上、セット実装を行い
 あらかじめ異常のないことをご確認願います。
 Regarding the operation of the lever, please
 consider the above mentioned, and make
 sure nothing is wrong with the operation
 under installing in your appliance
 that you plan to use our products actually.
4. ツマミ挿入及びレバー操作は、ホリウムマウント基板に
 ソリ(曲がり)のない状態で行って下さい。
 Knob assembly on the lever and functioning
 the lever to be performed under the condition
 of P. C. B. without warp.
5. 電圧調整形回路において出力側のインピーダンスが低い場合には抵抗体と摺動子間の
 接触抵抗の影響を受けることがありますのでインピーダンスを公称全抵抗値の100倍
 以上に設定願います。
 There is a possibility that might be affected by
 contact resistance of resistive element and wiper
 in case of low impedance of output side in voltage
 regulation circuit. for this reason, we require that
 you adjust to impedance of output side more than 100
 times of total resistance.

ALPS ELECTRIC CO., LTD.

				APPD.	CHKD.	DSGD.	TITLE
				漏設計技作 07.4.5 池之上	漏設計技作 07.4.5 大矢	漏設計技作 07.4.5 玉田	スライドホリウム 仕様書 SPECIFICATIONS
ORIGINAL	1991-07-03	Y.Y	K.N	S.A			DOCUMENT NO.
SYMB	DATE	APPD	CHKD	DSGD			450001-200

Circuit diagram

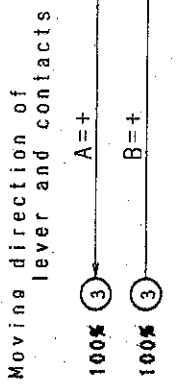
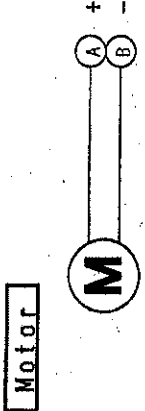

Audio track

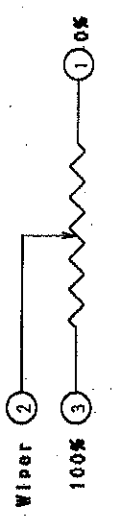

Servo track

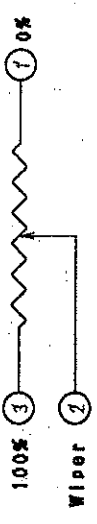

Touch line

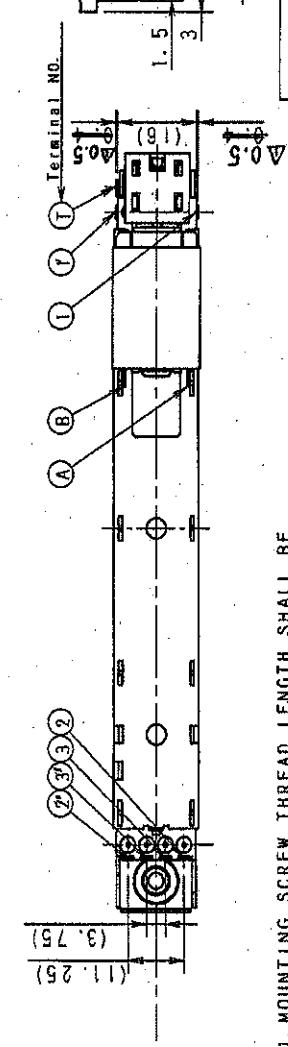
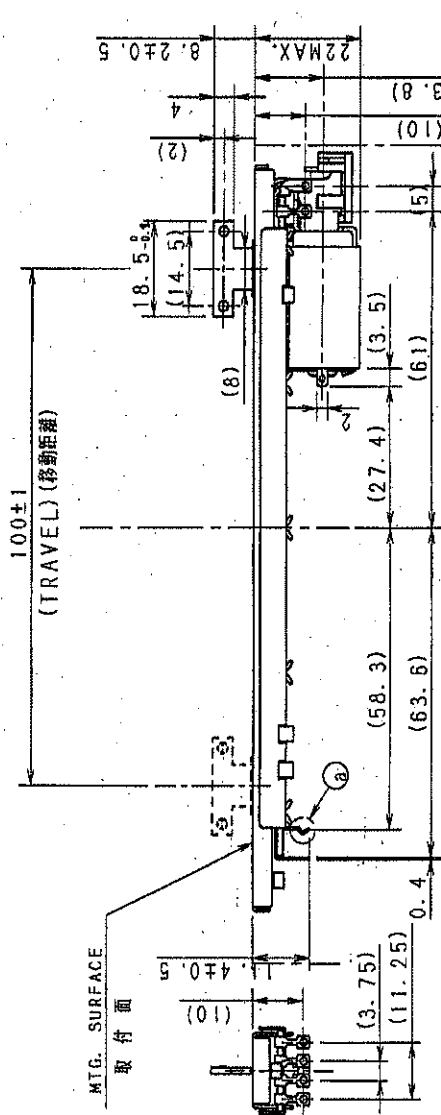
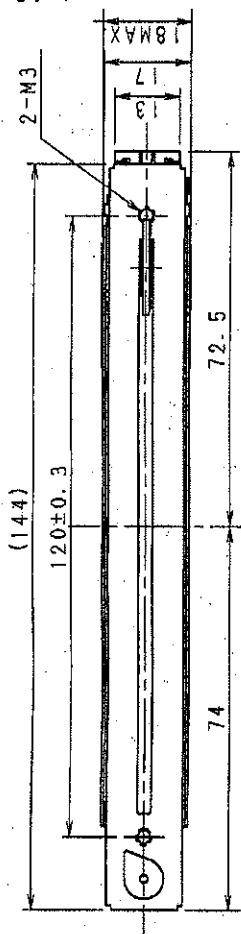
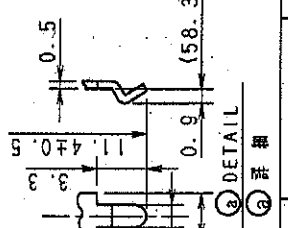
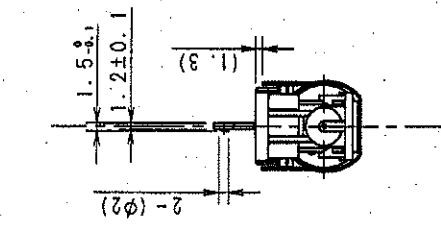
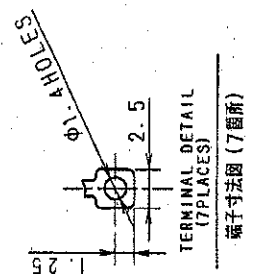
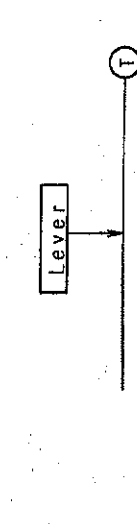

NOTES 1. MOUNTING SCREW THREAD LENGTH SHALL BE CHASSIS THICKNESS+3mm OR LESS.
 2. IN CASE OF PUTTING A KNOB ON THE LEVER, THE HEIGHT OF THE KNOB FROM MTG. SURFACE SHALL BE 25mm OR LESS.

注記 1. 取付用ネジの長さ等は、シャーシ板厚+3mm以下にてご利用願います。
 2. 取付面からツマミ先端まで25mm以内にてご利用願います。

ALPS ELECTRIC CO., LTD.

DSCD. 1-D56N2 SCALE N:1
 Y. WATANABE FEB. 04'97
 CRED. J. Kondo. FEB. 07'97
 APPD. J.Y.K.S.

NO. MOTORIZED FABER 100MM DUAL UNIT
 TITLE 100形 2重 七-9駆動フェーザ
 UNIT III DOCUMENT NO. SA02RM914

指定寸法部分の許容差 DIMENSIONS TOLERANCES SPEC.	
L ≤ 10	±0.3
10 < L ≤ 100	±0.5
100 < L ≤ 1000	±1.0
角度 ANGULAR DIMENSION	±5°