

Customer : ALPS ELECTRIC EUROPA GmbH

No. F3852683M

Attention:

Date: Nov. 16. 1994

Your ref. No:

Your Part. No: STRS60N07

SPECIFICATIONS

ALPS :

MODEL RS60N1211
(10KA X 2)

Spec. No. :

Sample No. : F3852683M

RECEIPT STATUS

RECEIVED

By. Date

Signature

Name

Title

ALPS ELECTRIC CO., LTD.

HEAD OFFICE
1-7, YUKIGAYA-OHTSUKA-CHO,
OHTA-KU, TOKYO 145 JAPAN

DSG'D M. Fujita

APP'D H. Ito

ENG. DEPT. DIVISION

Sales

SPECIFICATIONS

1. THIS SPECIFICATIONS APPLY TO RS60N1211 POTENTIOMETERS.

2. CONTENTS OF THIS SPECIFICATIONS.

4S602R-003
4S0001-200M
4S0001-202M
S602RG101

3. MARKING

• MARKING ON ALL UNITS
DATE CODE, RESIST. VALUE, TAPER, TRADE MARK, JAPAN

4. REMARKS

• NOTES

• Marking ⇒ in specifications shows standard and condition for application.

1. Environment 一般事項

1.1 Operating temperature range 使用温度範囲 -10-60°C

1.2 Storage temperature range 保存温度範囲 -30-70°C

1.3 Test conditions 試験条件

Unless otherwise specified, the standard range of atmospheric conditions for making measurements and test is as follows.

- Ambient temperature: 5°C to 35°C
- Relative humidity : 45% to 85%
- Air pressure : 860mbar to 1060 mbar.

If there is any doubt about the results, measurements shall be made within the following limits.

- Ambient temperature: 20±2°C
- Relative humidity : 60 to 70%
- Air pressure : 860mbar to 1060 mbar.

試験及び測定は特に規定がない限り温度5-35°C、相対湿度45-85%、気圧860-1060mbarの標準状態のもとで行う。

ただし、判定に疑義を生じた場合は温度20±2°C、相対湿度65±5%、気圧860-1060mbarにて行う。

2. Appearance 外観

The potentiometer shall be well done and not have any excessive rust, crack, split, poor plating and discolor in any portion.

各部の仕上げは良好で換装上有害なサビ、キズ、ワレ、メッキ不良及び剥離などがあってはならない。

3. Electrical characteristics 電気的仕様

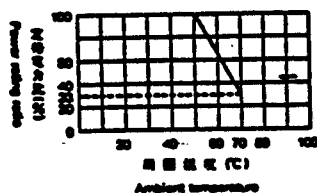
Item 項目	Conditions 条件	Specifications 規格				
		5	10	20	50	100
3.1 Nominal total resistance and tolerance 公称全抵抗値および許容差	Measurement shall be made by the resistance between terminal 1 and 3 with lever setted at terminal 1 or 3. レバーを端子1又は、3の終端におき、抵抗器の端子1-3間の抵抗値を測定する。	200	250	500	±20%	
3.2 Power rating 定格電力	Power rating is based on continuous full load operation at the maximum voltage between terminals 1 and 3. Power rating vs. ambient temperature shall be denoted on the following graph. 端子1と3の間に連続負荷することができる最大電力。周囲温度に対する電力降減曲線は右図とする。 	0.1w				
3.3 Rated voltage 定格電圧	Rated voltage 定格電圧 $E = \sqrt{PR}$ (V) P: Power rating 定格電力 (W) R: Nominal total resistance 公称全抵抗値 (Ω) When the rated voltage exceeds the maximum operating voltage, the maximum operating voltage shall be the rated voltage. ただし、定格電圧が最高使用電圧を越える場合は、この最高使用電圧を定格電圧とする。	Maximum operating voltage 最高使用電圧			DC 10V AC150V	
3.4 Resistance law (Taper) 抵抗変化特性	Measurement shall be made by the resistance law method, 電圧法にて測定 Measurement shall be made at the position of right diagram from the edge at the side of terminal 1. When based on terminal 3, from the edge at the side of terminal 3. Output voltage between terminals 1 and 2 Applied voltage between terminals 1 and 3 $\frac{1-2 \text{端子間出力電圧}}{1-3 \text{端子間印加電圧}} \times 100(\%)$ Output voltage between terminals 1 and 2 Applied voltage between terminals 1 and 3 (dB) $20 \log \frac{1-2 \text{端子間出力電圧}}{1-3 \text{端子間印加電圧}} \text{ (dB)}$	Resistance law (Taper) 抵抗変化特性 A, B, C D, K,			Refer to page 5/5 6/6 5/5ページ参照	

 ALPS ELECTRIC CO., LTD.				
APPD.	CHKD.	DSGD.	TITLE	
Sep. 12 '91	Sep. 11 '91	Sep. 9 '91	SPECIFICATIONS	
Y.Y	G. Ahe	H. Morisawa	DOCUMENT NO.	
			4S602R-003 (1/6)	

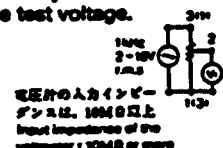
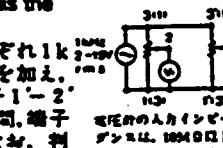
Item 項目	Conditions 条件	Specifications 規格										
3.5 Attenuation and insertion loss 最大減衰量と挿入損失	<p>The attenuation and insertion loss at each end of lever travel shall be measured. しゅう動子を移動距離の各終端に置いたとき 最大減衰量、挿入損失を測定する。</p> <p>The voltage of 2 Vr.m.s. to 15 Vr.m.s. shall be applied between terminal 1 and 3 by measuring frequency at 1 kHz. The output voltage shall be measured between terminals 1 and 2 and between terminals 2 and 3. If there is not any doubt about the results, DC voltage shall be used as the test voltage. 端子1-3間に1kHzで2-15V (正弦波実効値)の電圧を加え、端子1-2間、端子2-3間の出力電圧を測定する。なお、判定に疑義が生じなければ、試験電圧として直流を用いてもよい。</p>  <p>電圧計の入力インピーダンスは、10MΩ以上 Input impedance of the voltmeter: 10MΩ or more</p>	<table border="1"> <tr> <td>Nominal total resistance 公称全抵抗値 (kΩ)</td> <td>Attenuation 最大減衰量 (dB or more) 以上</td> </tr> <tr> <td>5 ≤ Ra ≤ 10</td> <td>70</td> </tr> <tr> <td>10 < Ra ≤ 50</td> <td>80</td> </tr> <tr> <td>50 < Ra ≤ 100</td> <td>90</td> </tr> <tr> <td>100 < Ra ≤ 500</td> <td>100</td> </tr> </table> <p>Insertion loss 挿入損失 within 0.1 dB以内</p>	Nominal total resistance 公称全抵抗値 (kΩ)	Attenuation 最大減衰量 (dB or more) 以上	5 ≤ Ra ≤ 10	70	10 < Ra ≤ 50	80	50 < Ra ≤ 100	90	100 < Ra ≤ 500	100
		Nominal total resistance 公称全抵抗値 (kΩ)	Attenuation 最大減衰量 (dB or more) 以上									
		5 ≤ Ra ≤ 10	70									
		10 < Ra ≤ 50	80									
50 < Ra ≤ 100	90											
100 < Ra ≤ 500	100											
3.6 Noise しゅう動雑音	<p>DC 20V, when the rated voltage is 20V or less, its rated voltage shall be applied to the terminals between 1 and 3. And then the noise shall be measured by the specified speed. For other procedures, refer to IEC Pub. 393-1-6, Test Method B. Traveling speed: 20mm/sec 端子1-3間に直流電圧20V (定格が20V以下の時は、その電圧)を加え、レバーを20mm/秒の速さで移動させ、このときに発生する雑音電圧を測定する。その他 JIS C 5261A法による。</p>	<table border="1"> <tr> <td>Nominal total resistance 公称全抵抗値 (kΩ)</td> <td>(mVP-P) 未満</td> </tr> <tr> <td>5 ≤ Ra ≤ 50</td> <td>47</td> </tr> <tr> <td>50 < Ra ≤ 500</td> <td>85</td> </tr> </table>	Nominal total resistance 公称全抵抗値 (kΩ)	(mVP-P) 未満	5 ≤ Ra ≤ 50	47	50 < Ra ≤ 500	85				
		Nominal total resistance 公称全抵抗値 (kΩ)	(mVP-P) 未満									
5 ≤ Ra ≤ 50	47											
50 < Ra ≤ 500	85											
3.7 Insulation resistance 絶縁抵抗	<p>A voltage of 250V DC shall be applied for 1 min., after which measurement shall be made. D.C. 250Vの電圧を印加して測定。(1分間)</p>	<p>Between individual terminals and frame/lever Between adjacent terminals 端子-レバー間 端子-枠間 独立した抵抗素子の端子間</p> <p>100MΩ or more 以上</p>										
3.8 Dielectric strength 耐電圧	<p>Trip current: 2mA Measuring frequency: 50/60Hz 250V AC for 1 min. A.C. 250Vr.m.s. 1分間。 感度電流 2mA (周波数50/60Hz)</p>	<p>Between individual terminals and frame/lever Between adjacent terminals</p> <p>Without damage to parts, arcing or breakdown etc. 損傷、アークおよび絶縁破壊を生じないこと。</p>										
3.9 Tracking error 相互偏差	<p>The voltage of 2 Vr.m.s. to 15 Vr.m.s shall be applied between terminals 1 and 3 and between terminals 1 to 3 by measuring frequency at 1 kHz. The output voltage shall be measured between terminals 1 and 2 (for the C and RD taper, the measurement shall be made between terminals 2 and 3 and between terminals 2 and 3) the first of these shall be the standard one. If there is not any doubt about the results, DC voltage shall be used as the test voltage. 端子1-3間、端子1-3'間にそれぞれ1kHzで2-15V (正弦波実効値)の電圧を加え、前段を基準として端子1-2間、端子1-2'間(3端子基準の場合は、端子2-3間、端子2-3'間)の出力電圧を測定する。なお、判定に疑義が生じなければ、試験電圧として直流を用いてもよい。</p>  <p>電圧計の入力インピーダンスは、10MΩ以上 Input impedance of the voltmeter: 10MΩ or more</p>	<table border="1"> <tr> <td>At 50% of lever travel 移動距離の50%の位置</td> <td>± _ dB</td> </tr> <tr> <td>40dB-0dB</td> <td>± 3dB</td> </tr> <tr> <td>dB-dB</td> <td>± dB</td> </tr> <tr> <td>dB-dB</td> <td>± dB</td> </tr> </table>	At 50% of lever travel 移動距離の50%の位置	± _ dB	40dB-0dB	± 3dB	dB-dB	± dB	dB-dB	± dB		
At 50% of lever travel 移動距離の50%の位置	± _ dB											
40dB-0dB	± 3dB											
dB-dB	± dB											
dB-dB	± dB											

ALPS ELECTRIC CO., LTD.

APPD.	CHKD.	DSCD.	TITLE
<i>[Signature]</i>	<i>[Signature]</i>	<i>[Signature]</i>	SPECIFICATIONS
SYMB.	DATE	APPD.	CHKD.
DOCUMENT NO.			4S602R-003 (2/6)

4. Mechanical characteristics 機械的性能

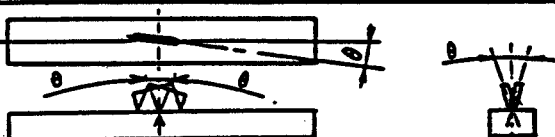
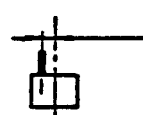
Item 項目	Conditions 条件	Specifications 規格
4.1 Lever travel- レバー 移動距離		60 ± 0.5 mm
4.2 Operating force 作動力	Traveling speed: 20mm/sec Operating position: Tip of the lever 移動速度は20mm/秒とする。 操作位置はレバー先端部とする。	80 gf ± 50 gf
	Starting force 始動力	Traveling speed: 20mm/sec Operating position: Tip of the lever 移動速度は20mm/秒とする。 操作位置はレバー先端部とする。 Operating force +100gf max. 作動力+100gf以下
4.3 Lever travel stop strength レバーの移動 止強度	A static load of 10Kgf shall be applied at the point 5mm from top surface of the case for both ends in the direction of lever travel for 10sec. レバー移動距離の両末端において、枠上面より5mmの位置に10Kgfの静荷重を10秒間加える。	Without excessive play or poor contact 著しいガタ、および接触不良を生じないこと。
4.4 Side thrust of the lever レバーの横押し 強度	A static load of 2Kgf shall be applied at the point 5mm from top surface of the case in a direction perpendicular to the axial direction for 10sec., with the potentiometer mounted in assembly conditions. 本体をシャーシに固定し、枠上面より5mmの位置にレバー移動方向に対して直角方向に2Kgfの静荷重を10秒間加える。	Without deformation or breaks in the sliding part and contact part. 操作部および関連部品に変形、破損がないこと。
4.5 Thrust and tensile lever レバーの押し 引き強度	Thrust and tensile static load of 5 kgf shall be applied to the potentiometer in the lever direction for 10 sec. レバーの押し方向および引っ張り方向に5kgfの静荷重を10秒間加える。	Without damage such as bed sliding and braking or play in the lever. Electrical characteristics shall be satisfied. レバーのガタ、および破損、しゅう動ムラ等がなく、電気的性能を満足すること。
4.6 Displacement of lever レバーの横揺れ	A torsion moment of 250gf.cm shall be applied at the lever in a direction perpendicular to the axial direction and then the displacement shall be measured. レバーに250gf.cmの曲げモーメントを移動方向に対して直角に加えレバー先端で測定する。	or less 2(2 x L/25) sin P 以下 L=Length of lever レバー長さ
4.7 Lever inclination and torsion レバーの傾き およびねじれ		θ shall be 2° or less. Return to the same position after torsion. θは2度以下。また、ひねりを加えた時、元に戻ること。
4.8 Distance from the center of the lever レバーのセン ターズレ	After sliding lever as far as it will go in each direction, the distance from the center of the lever to the middle of the mounting screw hole shall be measured at the both ends. 取付けネジ穴中心に対するレバーのセンターからのずれを片側ごとに測定する。 	0.5mm or less on each end. 片側0.5mm以下。
4.9 Resistance to soldering heat はんだ耐熱	Bit temperature: 350°C or less Application time of soldering iron: 5 sec or less 温度350°C以下。時間5秒以内。 ただし、端子に異常加圧のないこと。	Change in total resistance is relative to the value before test: 5% Without excessive looseness of terminals and failure contact. 全抵抗値の変化は初期値の±5%以内。 著しいガタ、接触不良を生じない。

					 ALPS ELECTRIC CO., LTD.		
				APPD.	CHKD.	DSGD	TITLE
				Sep. 12 '91	Sep. 11 '91	Sep. 9 '91	SPECIFICATIONS
							DOCUMENT NO.
							4S602R-003 (3/6)
SYMB.	DATE	APPD.	CHKD.	DSGD.			

5. Endurance 耐久性能

Item 項目	Conditions 条件	Specifications 規格															
5.1 Endurance without load 無負荷しゅう動寿命	<p>The moving contact, without electrical load, shall be slid from one end stop to the other and returned to its original position extended over 90% or more effective distance. This procedure constitutes 1 cycle. And the moving contact shall be subjected to 600 cycles per hour, a total of 30000 ± 200 cycles (5,000 to 8,000 continuous cycles for 24 hours.)</p> <p>無負荷にてレバーを 600 サイクル/時の速さで有効移動距離の 90%以上にわたり、1日連続5000-8000サイクル、合計30000 ± 200サイクル移動させる。</p>	<p>Change in total resistance is relative to the value before test: ±15% Noise: Refer to Note 1) Operating force: 10-200gf Clause (3), (4) shall be satisfied.</p> <p>全抵抗値の変化は初期値の±15%以内しゅう動雑音は注記 1)による。作動力 10-200gf その他は、(3項)(4項)を満足すること。</p>															
5.2 Cold 耐寒性	<p>The potentiometer shall be stored at a temperature of -30 ± 2°C for 96 hours in a thermostatic chamber. Then the potentiometer shall be taken out of the chamber and its surface moisture shall be removed. And then the potentiometer shall be subjected to standard atmospheric conditions for 1 hour, after which measurement shall be made.</p> <p>-30 ± 2°Cの恒温槽中にて96時間放置し、常温常温中に1時間放置後1時間以内に測定する。ただし水滴は、取り除くものとする。</p>	<p>Change in total resistance is relative to the value before test: ±20% Clause (3) (4) shall be satisfied.</p> <p>全抵抗値の変化は初期値の±20%以内その他は、(3項)(4項)を満足すること。</p>															
5.3 Dry heat 耐熱性	<p>The potentiometer shall be stored at a temperature of 70 ± 2°C for 240 ± 8 hours in a thermostatic chamber. Then the potentiometer shall be maintained at standard atmospheric conditions for 1 hour, after which measurements shall be made.</p> <p>70 ± 2°Cの恒温槽中にて240 ± 8時間放置し、常温常温中に1時間放置後1時間以内に測定する。</p>	<p>Change in total resistance is relative to the value before test: + 5 - 30%. Noise: Refer to Note 1) Operating force: 10-200gf Clause (3) (4) shall be satisfied.</p> <p>全抵抗値の変化は初期値の+5 - -30%以内しゅう動雑音は注記 1)による。作動力 10-200gf その他は、(3項)(4項)を満足すること。</p>															
5.4 Damp heat 耐湿性	<p>The potentiometer shall be stored at a temperature of 40 ± 2°C with relative humidity of 90% to 95% for 96 ± 4 hours in a thermostatic chamber. And its surface moisture shall be removed. And then the potentiometer shall be subjected to standard atmospheric conditions for 1 hour, after which measurement shall be made.</p> <p>40 ± 2°C 相対湿度90-95%の恒温恒湿槽中にて96 ± 4時間放置し、常温常温中に1時間放置後1時間以内に測定する。ただし水滴は、取り除くものとする。</p>	<p>Change in total resistance is relative to the value before test: +35 - 5%. Noise: Refer to Note 1) Operating force: 10-200gf Clause (3) (4) shall be satisfied.</p> <p>全抵抗値の変化は初期値の+35 - -5%以内しゅう動雑音は注記 1)による。作動力 10-200gf その他は、(3項)(4項)を満足すること。</p>															
5.5 Change of temperature 温度サイクル	<p>The potentiometer shall be subjected to 5 successive change of temperature cycles, each as shown in table below. Then its surface moisture shall be removed. And then the potentiometer shall be subjected to standard atmospheric conditions for 1 hour, after which measurements shall be made.</p> <p>下記条件で5サイクル試験後、常温常温中に1時間放置後1時間以内に測定する。ただし水滴は、取り除くものとする。</p> <table border="1" style="margin: 10px auto; border-collapse: collapse; text-align: center;"> <thead> <tr> <th style="font-size: small;">Order No.</th> <th style="font-size: small;">Temperature 温度</th> <th style="font-size: small;">Duration 時間</th> </tr> </thead> <tbody> <tr> <td>1</td> <td>-10 ± 3°C</td> <td>30 Min, 30分</td> </tr> <tr> <td>2</td> <td>Standard atmospheric conditions 常温</td> <td>10-15 Min, 10-15分</td> </tr> <tr> <td>3</td> <td>70 ± 2°C</td> <td>30 Min, 30分</td> </tr> <tr> <td>4</td> <td>Standard atmospheric conditions 常温</td> <td>10-15 Min, 10-15分</td> </tr> </tbody> </table>	Order No.	Temperature 温度	Duration 時間	1	-10 ± 3°C	30 Min, 30分	2	Standard atmospheric conditions 常温	10-15 Min, 10-15分	3	70 ± 2°C	30 Min, 30分	4	Standard atmospheric conditions 常温	10-15 Min, 10-15分	<p>Change in total resistance is relative to the value before test: ±20% Noise: Refer to Note 1) Operating force: 10-200gf Clause (3) (4) shall be satisfied.</p> <p>全抵抗値の変化は初期値の±20%以内しゅう動雑音は注記 1)による。作動力 10-200gf その他は、(3項)(4項)を満足すること。</p>
Order No.	Temperature 温度	Duration 時間															
1	-10 ± 3°C	30 Min, 30分															
2	Standard atmospheric conditions 常温	10-15 Min, 10-15分															
3	70 ± 2°C	30 Min, 30分															
4	Standard atmospheric conditions 常温	10-15 Min, 10-15分															

ALPS ELECTRIC CO., LTD.					
		APPD.	CHKD.	DSGD.	TITLE SPECIFICATIONS
		<i>Sep. 12 '91</i>	<i>Sep. 11 '91</i>	<i>Sep. 9 '91</i>	DOCUMENT NO.
		<i>M. Yoshida</i>	<i>S. Aiba</i>	<i>M. Yamamoto</i>	4S602R-003 (4/6)
SYMB	DATE	APPD.	CHKD.	DSGD.	

CLASS.NO.

TITLE

MASTER TYPE POTENTIOMETER (SLIDE)

Note 1) For noise specification after the test, refer to the list below.

注記 1) 試験後のしゅう動雑音規格は、下表による。

Nominal total resistance 公称全抵抗値 (KΩ) $5 \leq R_a \leq 50$	Nominal total resistance 公称全抵抗値 (KΩ) $50 < R_a \leq 500$
Less than <u>150</u> mVP-P 未満	Less than <u>300</u> mVP-P 未満

2) Measurement of the endurance characteristic shall be made after 5 cycles' slide of moving contact

2) 耐久性能後の測定は、レバーを5サイクルしゅう動後とする。

△ 3) Prohibition of patten wiring for oblique line department.

3) 斜線部は、パターン配線を禁止します。

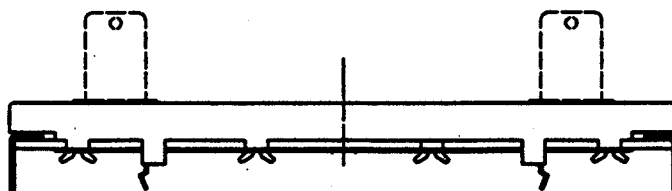

Viewed from mounting side

挿入側より

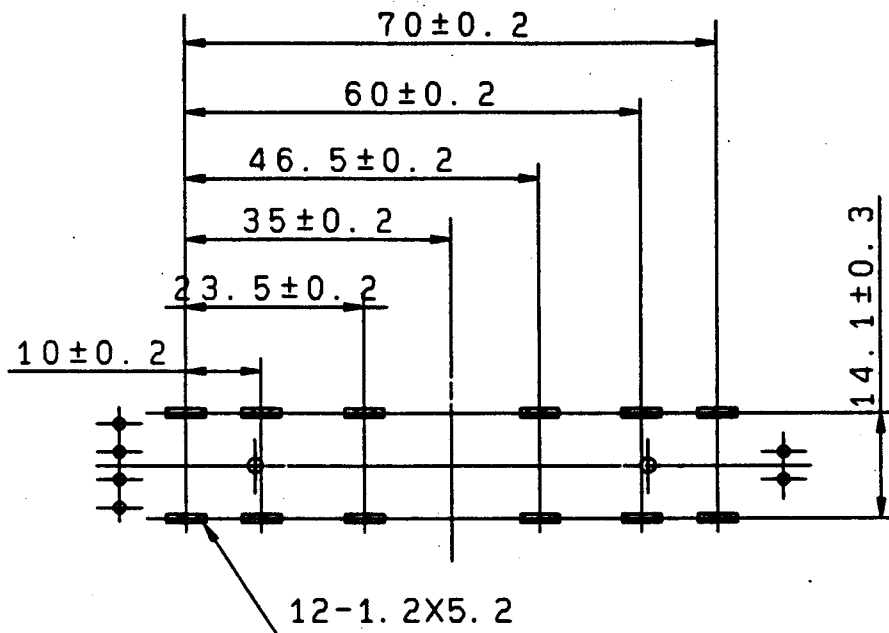

Unit: mm

					ALPS ALPS ELECTRIC CO., LTD.	
			APPD.	CHKD.	DSGD.	TITLE
			Apr. 17 '92		Apr. 17 '92	SPECIFICATIONS
						DOCUMENT NO.
						4S602R-003 (5/6)
SYMB.	DATE	APPD.	CHKD.	DSGD.		
△	Feb. 16 '94	Y.Y	G.O	S. Abe		

PRECAUTION IN USE

1. If it will be used the operating point away from the center line of the lever, it should be shorter as possible.
2. About the length of lever
If conditions permit, it is advisable to use the shortest possible lever. The longer the length up to operating point, the more unfavorable slide feeling will be given.

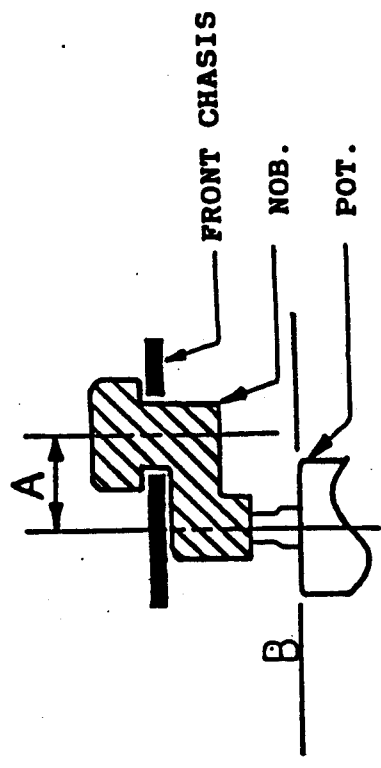

3. Regarding the operation of the lever, please consider the above mentioned, and make sure nothing is wrong with the operation under installing in your appliance that you plan to use our products actually.

ALPS ELECTRIC CO., LTD.			
APPD.	CHKD. DSCD.		
Aug. 9 / Aug. 9 / Aug. 9 / 91	Aug. 9 / Aug. 9 / Aug. 9 / 91		
TITLE SLIDE POTENTIOMETER			
DOCUMENT NO. 4S0001-200M			
DATE	APPR.	CHKD.	DSCD.

V. Narisawa G. Obe

OR

RESISTANCE LAW (TAPER) 抵抗変化特性規格

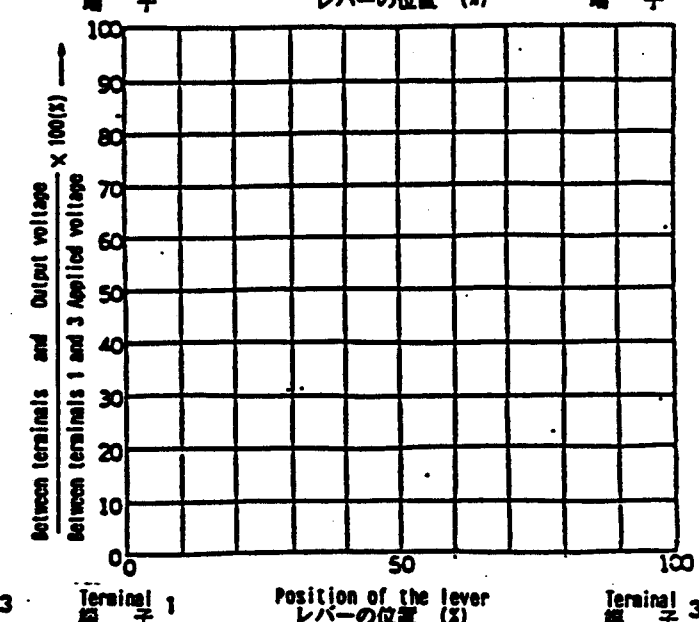
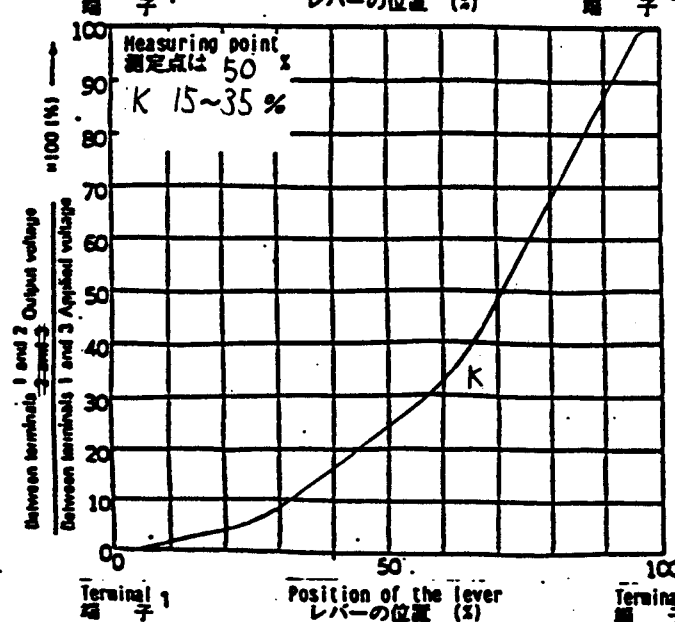
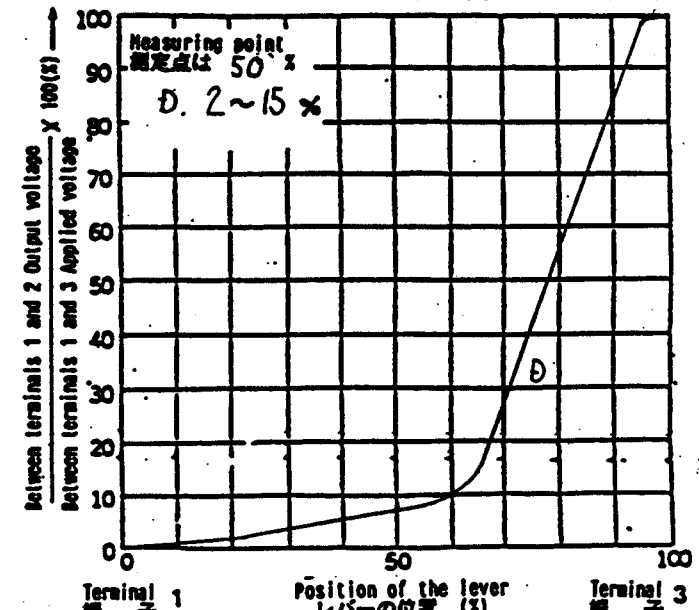
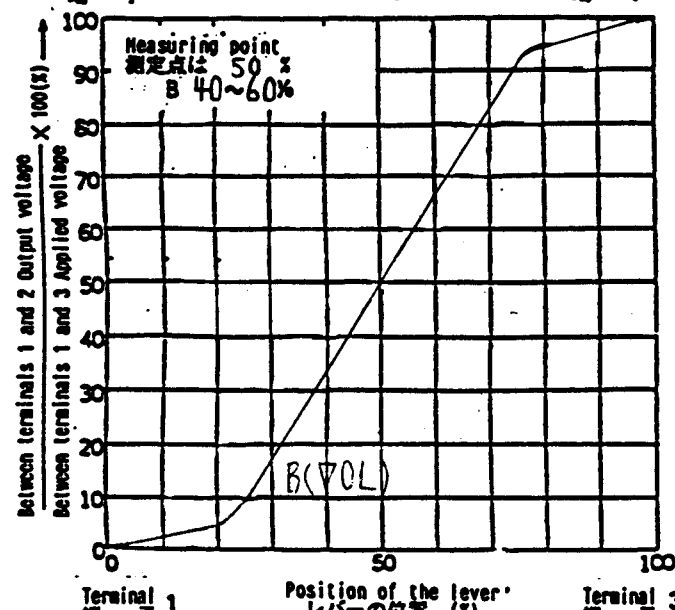
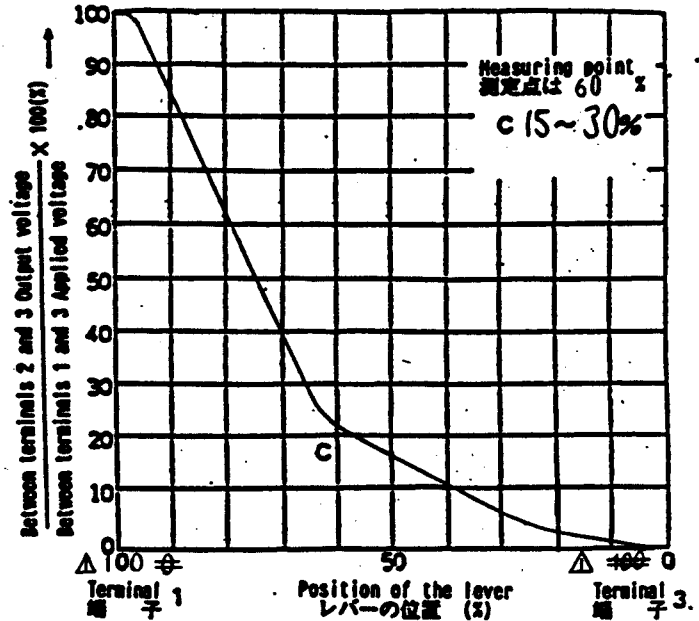
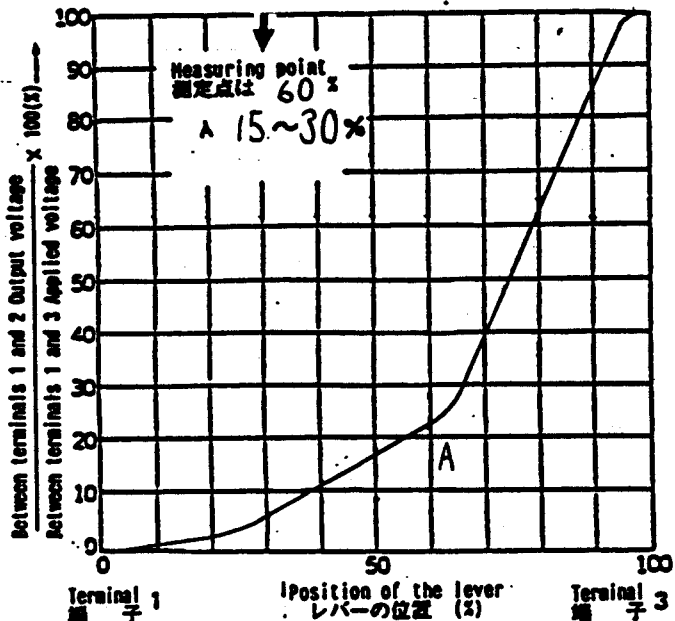

SYCS	DATE	APPD.	CHKD.	DSGD.	TITLE
3	10/2/91	Y.Y.	K.	T. Kumaga	SPECIFICATIONS
					DOCUMENT NO.
					4S602R-003 (5/6)

FOLLOW THE NEXT CONDITIONS FOR SOLDERING

1. Solder
63 % Sn solder specified in JIS Z3282.
2. Board in Use
Single-face copper laid laminate board.
Plate thickness (t) = 1.6 mm
3. In the Case of Dip Soldering
 - (1) State of potentiometer
Position a lever in the vicinity of center.
 - (2) Specific Gravity of Flux
0.83±0.01 (foaming type)
 - (3) Height of Flux face
A level of the upper face of flux for reaching the position at a half of the plate thickness of printed board. (Fig.1)
Further, no flow of flux invading on the surface of printed board on the side of installing potentiometer is allowed.

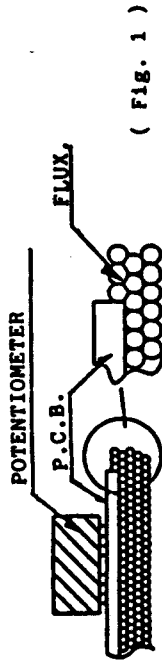

(Fig. 1)

- (4) Preheat Condition
100°C MAX., within 1 minute
(Temperature on the side of installing printed board is designated.)
- (5) Soldering Condition
Solder temperature; 260°C MAX.
Soldering period ; within 5 seconds
Time of soldering ; only one time is permitted
4. In the Case of Manual Soldering
Solder temperature ; 300°C MAX.
Soldering period ; within 3 seconds
Time of soldering ; only one time is permitted

5. Matters to Be Noted

- (1) Do not add any stress on terminals in the case of soldering.
For instance, forced movement of potentiometer with terminals being heated may probably deteriorate the electric features due to generation of looseness in connection between resistant board and terminals.
- (2) Use caution to soldering process so as to prevent solder from rising up to the surface of printed board on the side of installing potentiometer, because defective contact may take place in terminal connecting part due to soldering heat (Fig. 2)
- (3) In the case of lead wiring, solder it so that a gap of 1 mm or more may be reserved between the potentiometer body and soldering part. (Fig. 3)
- (4) The grade of influence of soldering exerted on the potentiometer depends upon the size of a printed board, installing position of the potentiometer, and the size of a solder bath etc. Therefore, make sure, in advance, of no abnormal state under the conditions of soldering to be carried out at present.

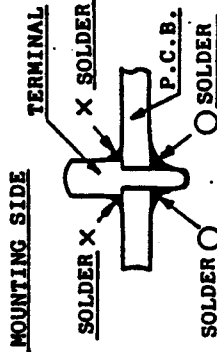

(Fig. 2)

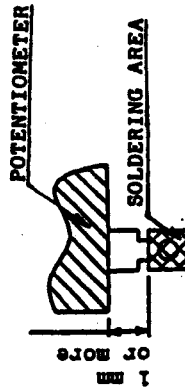

(Fig. 3)

SYMR	DATE	APPD.	CHKD.	DSCD.	TITLE
					ALPS ELECTRIC CO., LTD.
					TITLE
					SLIDE POTENTIOMETER
					DOCUMENT NO
					4S0001-202M

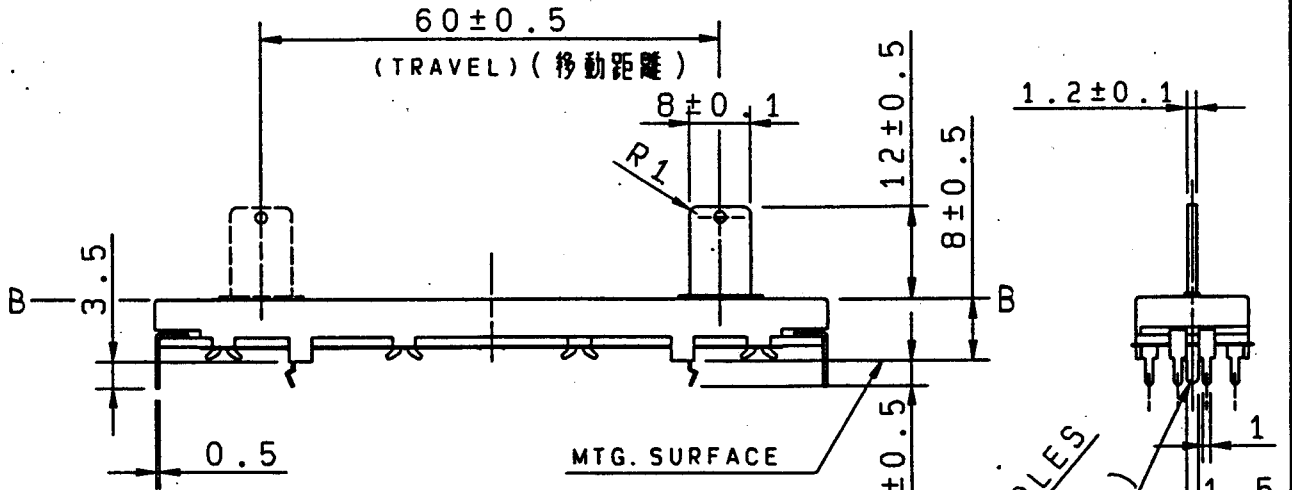
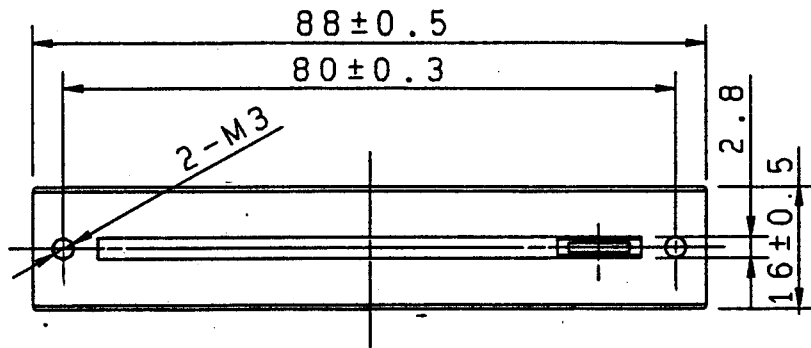

MOUNTING HOLE DETAIL (取付穴寸法図)
VIEWED FROM MOUNTING SIDE (挿入側より)

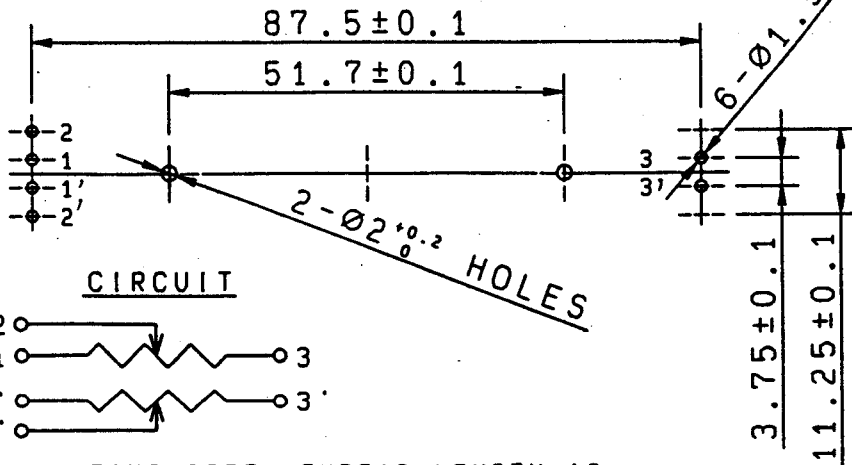

CIRCUIT

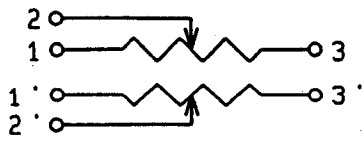

- NOTE 1. MOUNTING SCREW THREAD LENGTH IS CHASSIS THICKNESS+3mm MAX.
2. Within 30mm from B included knob's height.
- 注記 1. 取付ネジの首下長さはシャーシ板厚+3mm以下とする。
2. レバーの長さは、ツマミも含めて30mm以内にてご使用願います。

指定なき部分の許容差
TOLERANCES UNLESS OTHERWISE SPEC

$L \leq 10$	± 0.3
$10 < L \leq 100$	± 0.5
$100 < L$	± 0.8
角度 ANGULAR DIMENSION	$\pm 5^\circ$

PART NO.	NAME	MATERIAL NAME / CODE	FINISH
ALPS ELECTRIC CO., LTD.			
		DSGD. セツケ43 S. ABE 90-07-20	SCALE 1 : 1
		CHKD. <i>A. Narinawa</i> 90-10-17	FIGURE 60mm SLIDE POTENTIOMETER DUAL UNIT 28274F#U3-6
		APPD. <i>[Signature]</i> 90-10-19	UNIT mm
SYMB	DATE	APPD	RS60N1

①-12L
ポット
2連